

Adaptief deltamanagement

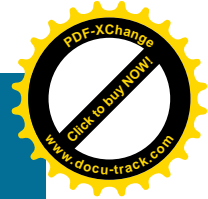

Pieter Bloemen,
Jos van Alphen
Staf Deltacommissaris

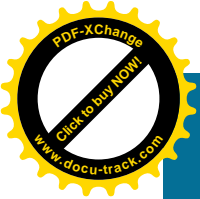

Het Deltaprogramma:

1. Koersvast op het wat:

- Waterveiligheid
- Zoetwatervoorziening

→ *Deltawet / Deltafonds / Deltacommissaris*

2. Flexibel in het hoe en wanneer (uitvoering):

- hoe: optiewaarde benadering
- wanneer: verbinden LT-KT

→ *Adaptief deltamanagement*

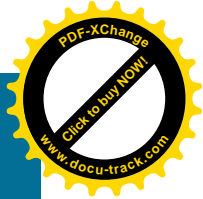
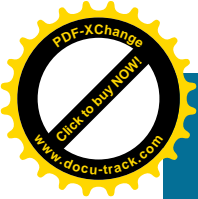

A. Flexibiliteit in het 'hoe'

Deltascenario 1

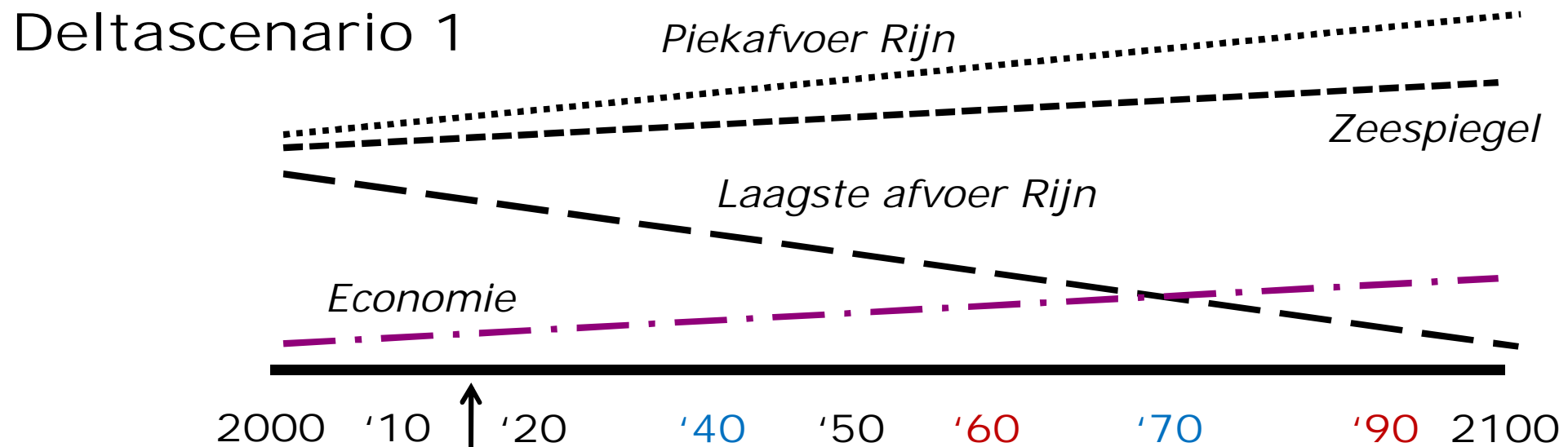

Veiligheid / zoetwater

Inlaatpunt Gouda verzilt
Maeslant -kering
Verziltling W-Nl.
Dordrecht

Investeringspad 1 (Opg./Amb.)



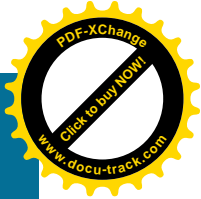
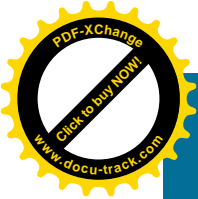

A. Flexibiliteit in het 'hoe'



Deltascenario 1

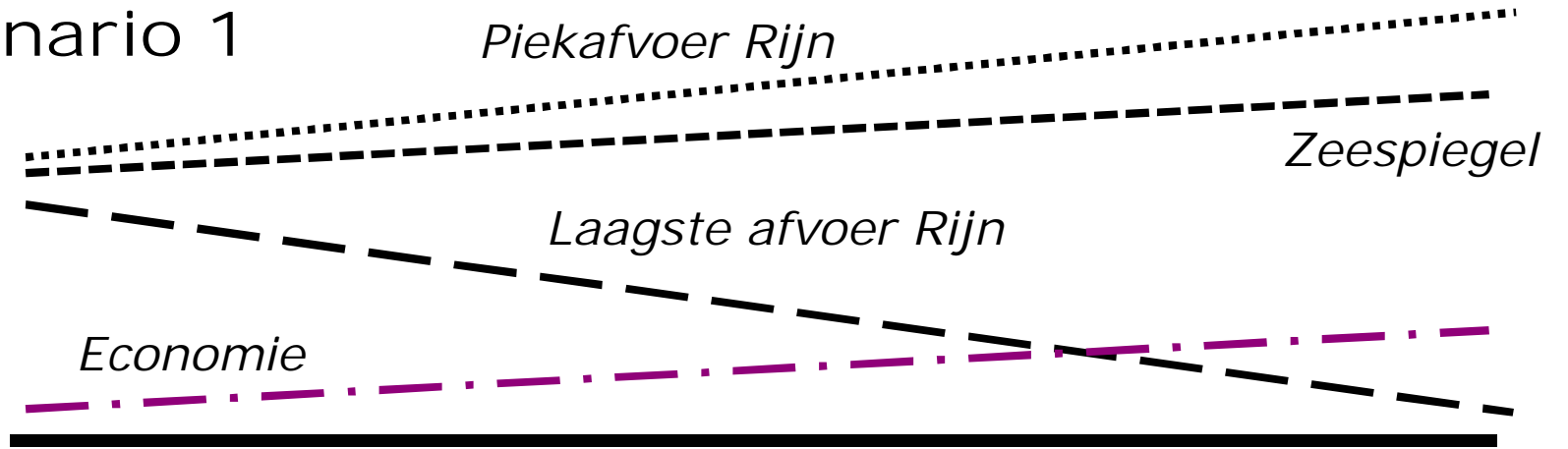

2000 '10 '20 '40 '50 '60 '70 '90 2100

Veiligheid / zoetwater



Deltascenario 2

Deltascenario 3

Deltascenario 4

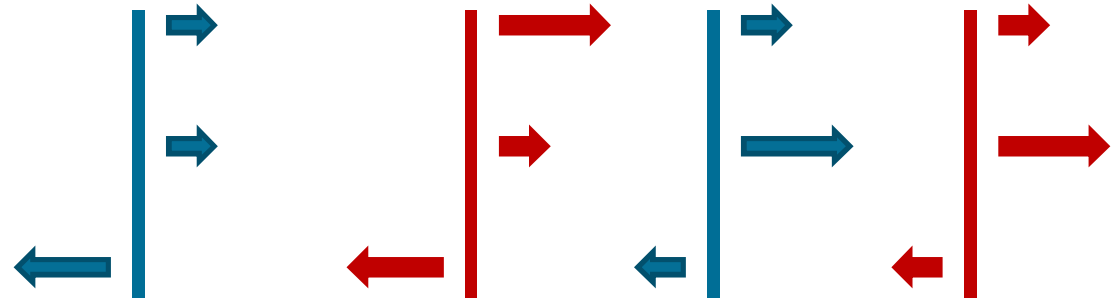

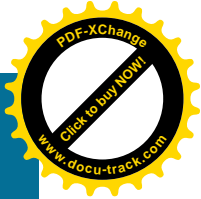

A. Flexibiliteit in het 'hoe'



Deltascenario 1

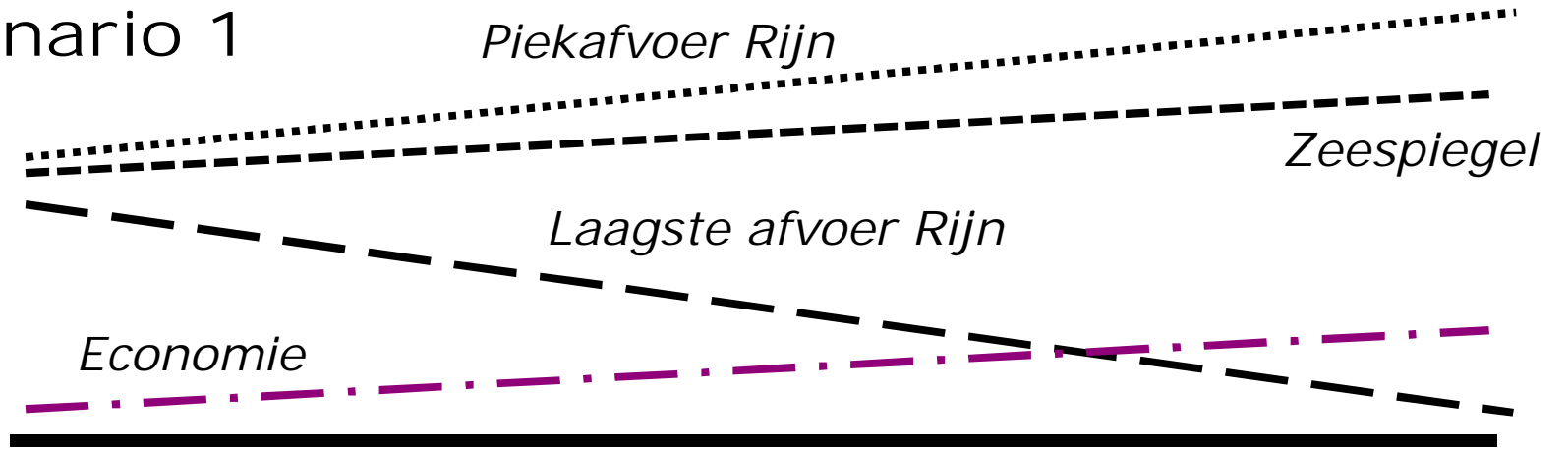

2000 '10 '20 '40 '50 '60 '70 '90 2100

Veiligheid / zoetwater



Deltascenario 2

Deltascenario 3

Deltascenario 4

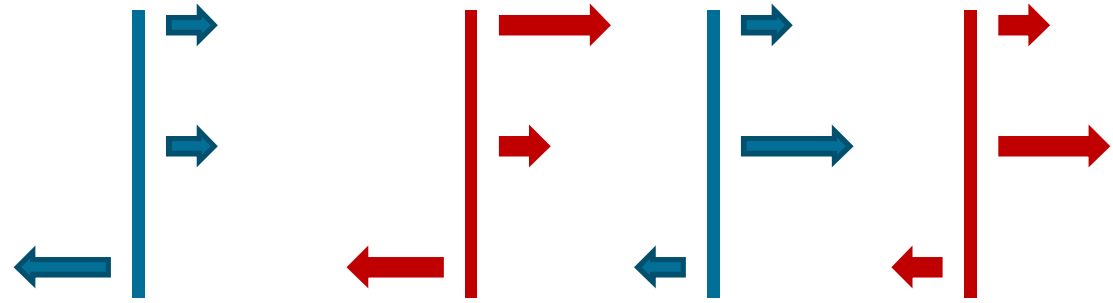

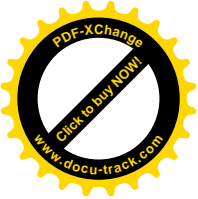

Voorbeeld Omslagpunten-Beleidsanalyse IJsselmeergebied

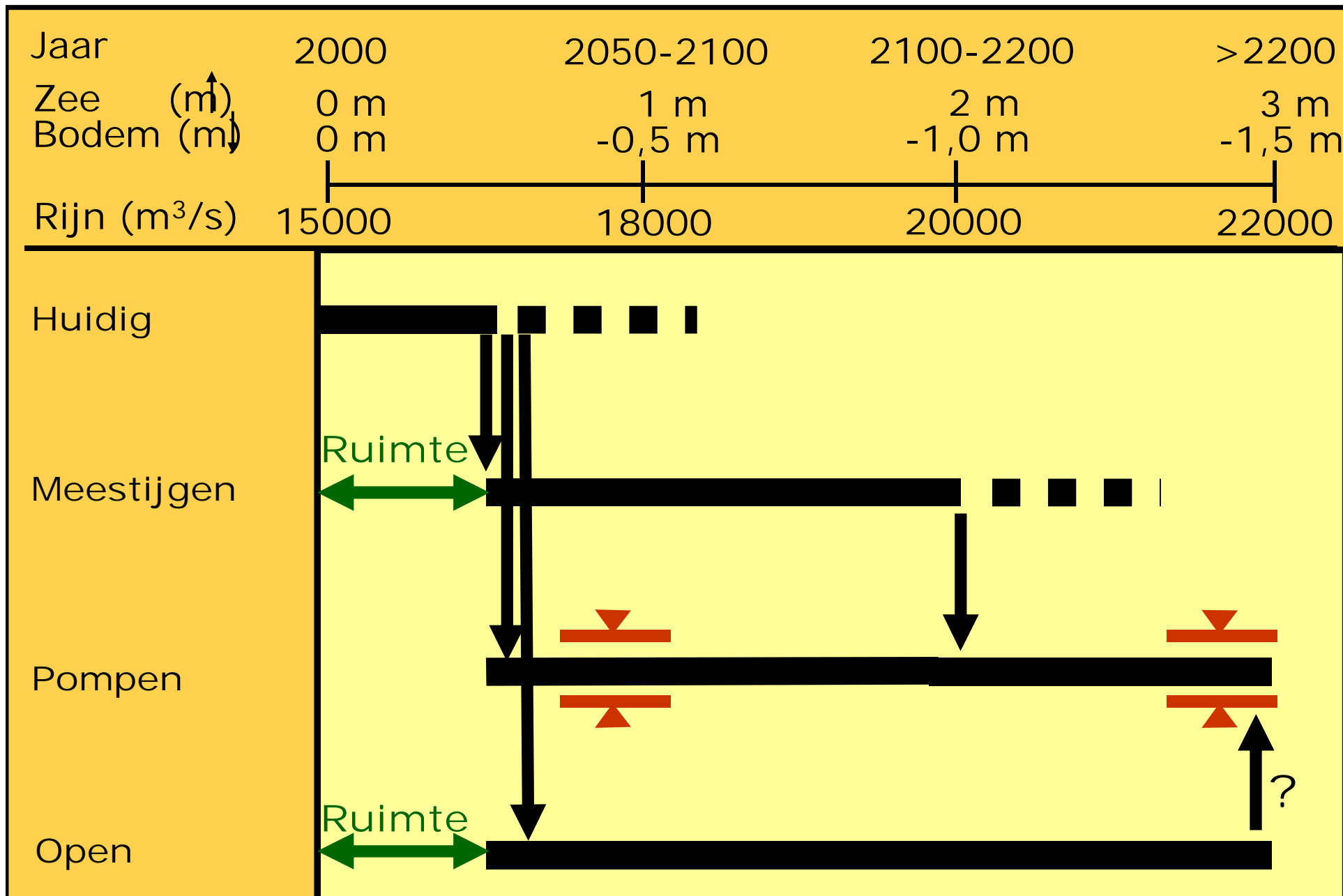

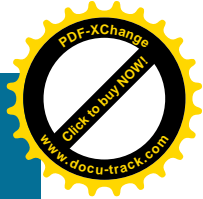
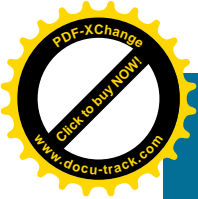

A. Flexibiliteit in het 'hoe'



Casus Deelprogramma IJsselmeergebied

IJsselmeergebied

Jaar	2000	2050-2100	2100-2200	>2200
Zee (m) ↑	0 m	1 m	2 m	3 m
Bodem (m) ↓	0 m	-0,5 m	-1,0 m	-1,5 m
Rijn (m ³ /s)	15000	18000	20000	22000

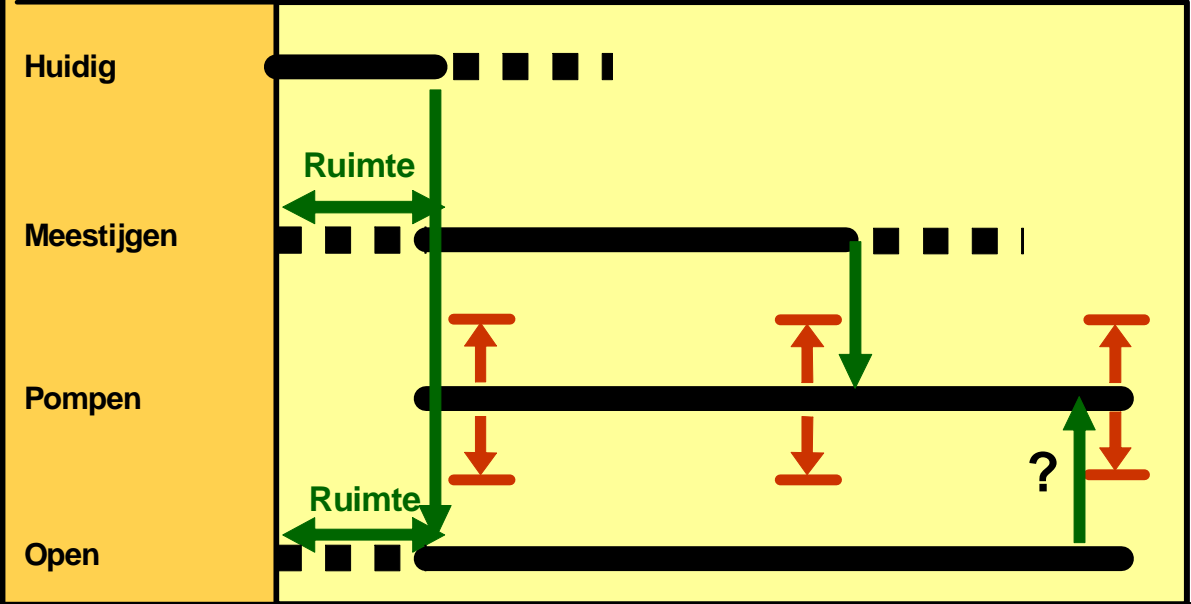

	Kosteneffectiviteit	Koppelkansen	Natuur	Watervoorziening	Economische functies	Flexibiliteit/ Aanpasbaarheid	Bestuurlijk/maatschappelijke acceptatie
Huidig	-		-	o	o	--	b
Meestijden	o		+	++	o	+	b
Pompen	o		--	o	o	--	b
Open	--		++	--	--	++	b

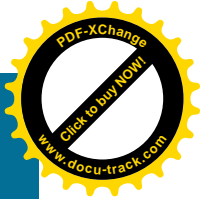
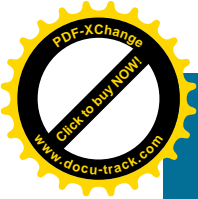

A. Flexibiliteit in het 'hoe'



Casus Deelprogramma Rotterdam- Drechtst.

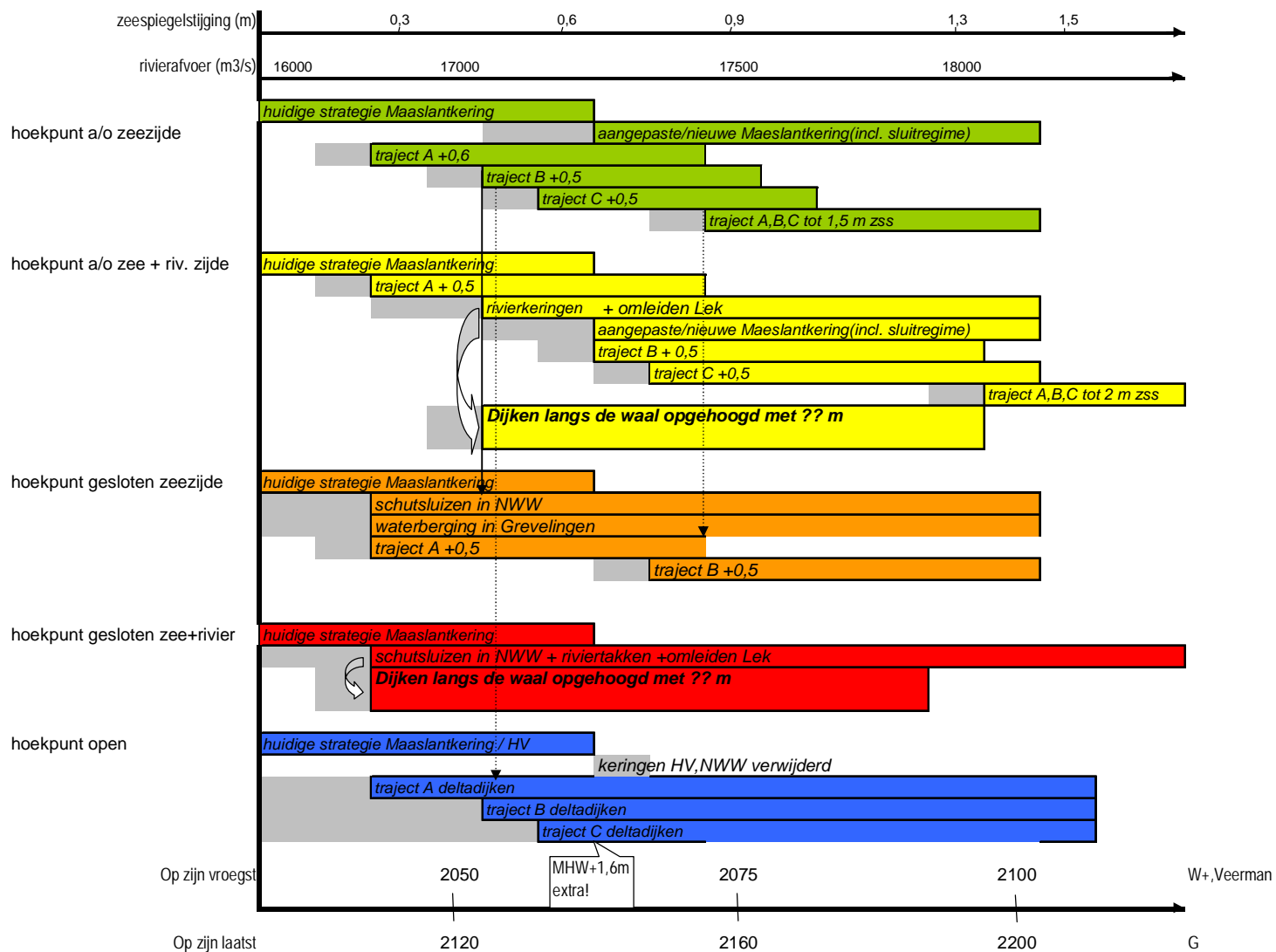

A. Flexibiliteit in het 'hoe'



Reele optie benadering

Wegverbreding A27
(Stratelligence)

Zandsuppletie vs harde dijk
(Blueconomy en IHE)

Verdieping Twentekanalen
(Stratelligence)

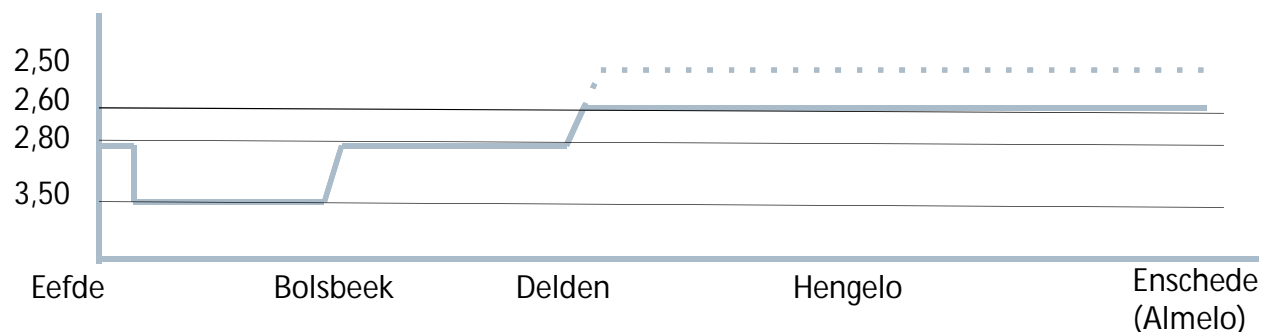

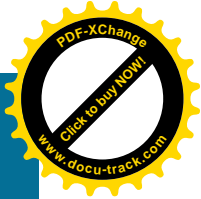
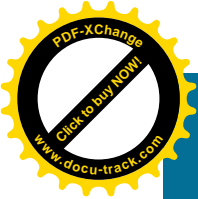

B. Flexibiliteit in het 'wanneer'



Invalshoek:
→ klimaatverandering

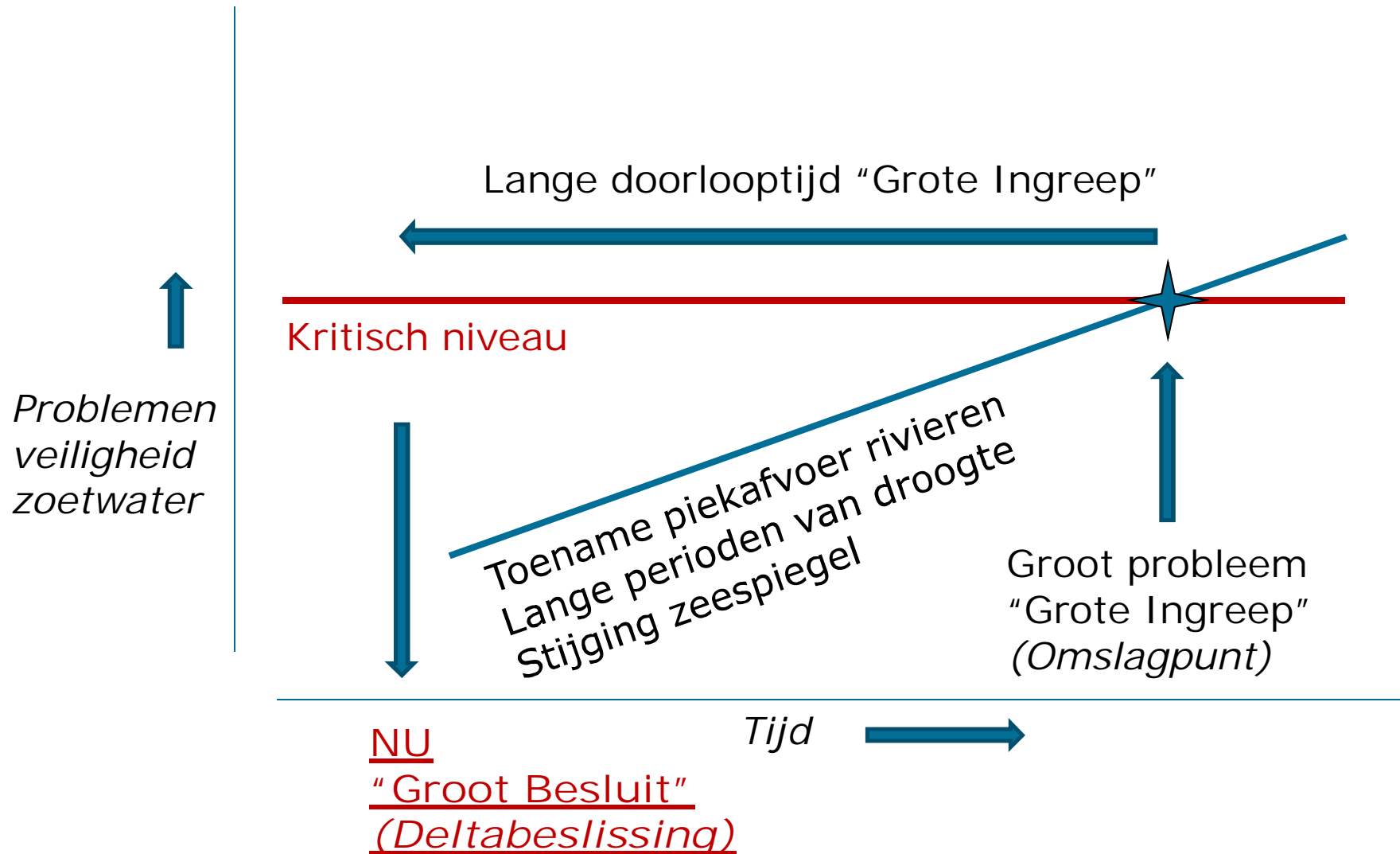

B. Flexibiliteit in het 'wanneer'



Invalshoek:
→ ruimtelijke ontwikkelingen

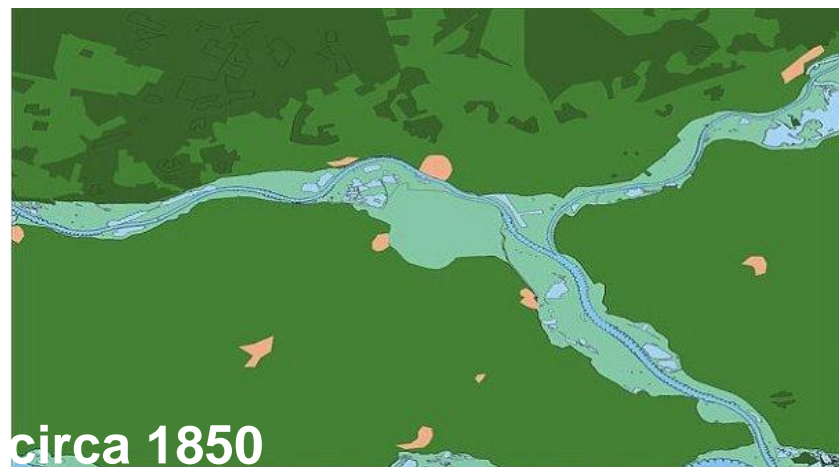
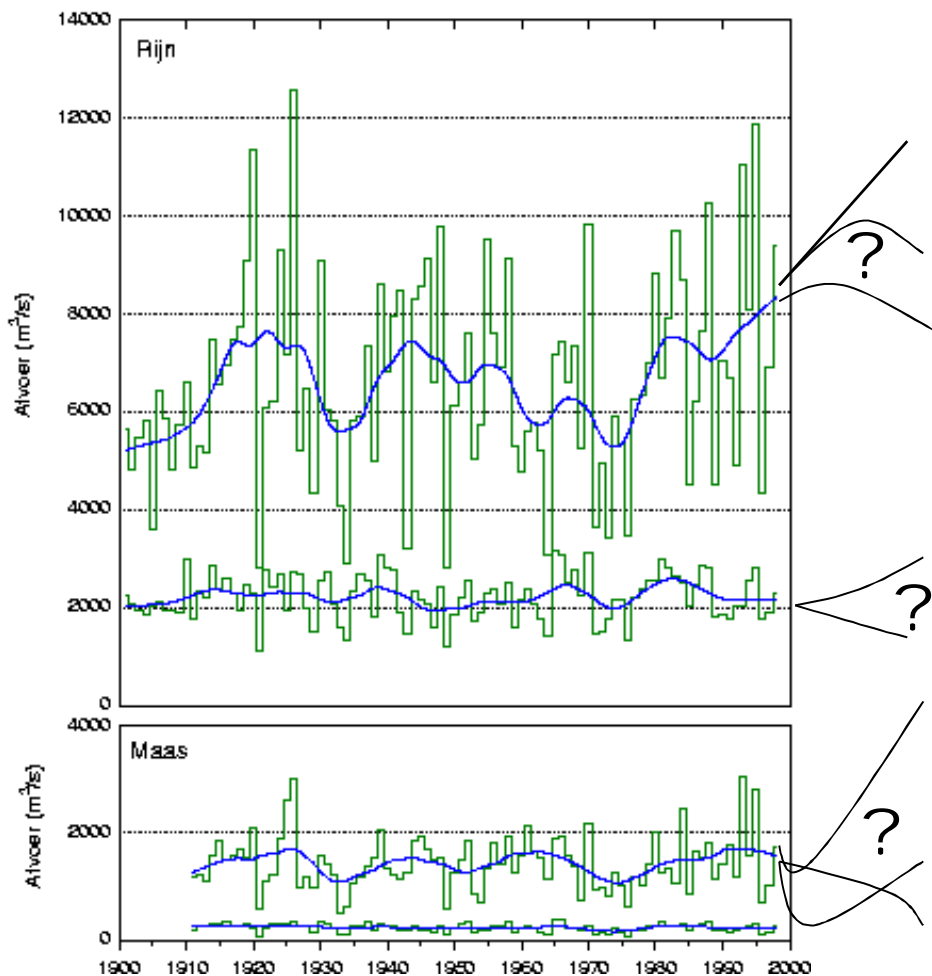

KV: benodigde rob./flex. neemt toe

RO: beschikbare flexibiliteit neemt af

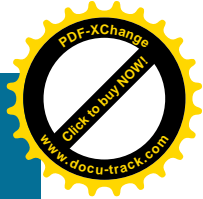
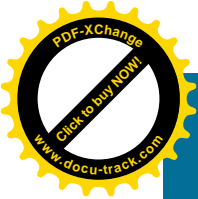

B. Flexibiliteit in het 'wanneer'



Invalshoek:
 → klimaatverandering
 → ruimtelijke ontwikkelingen

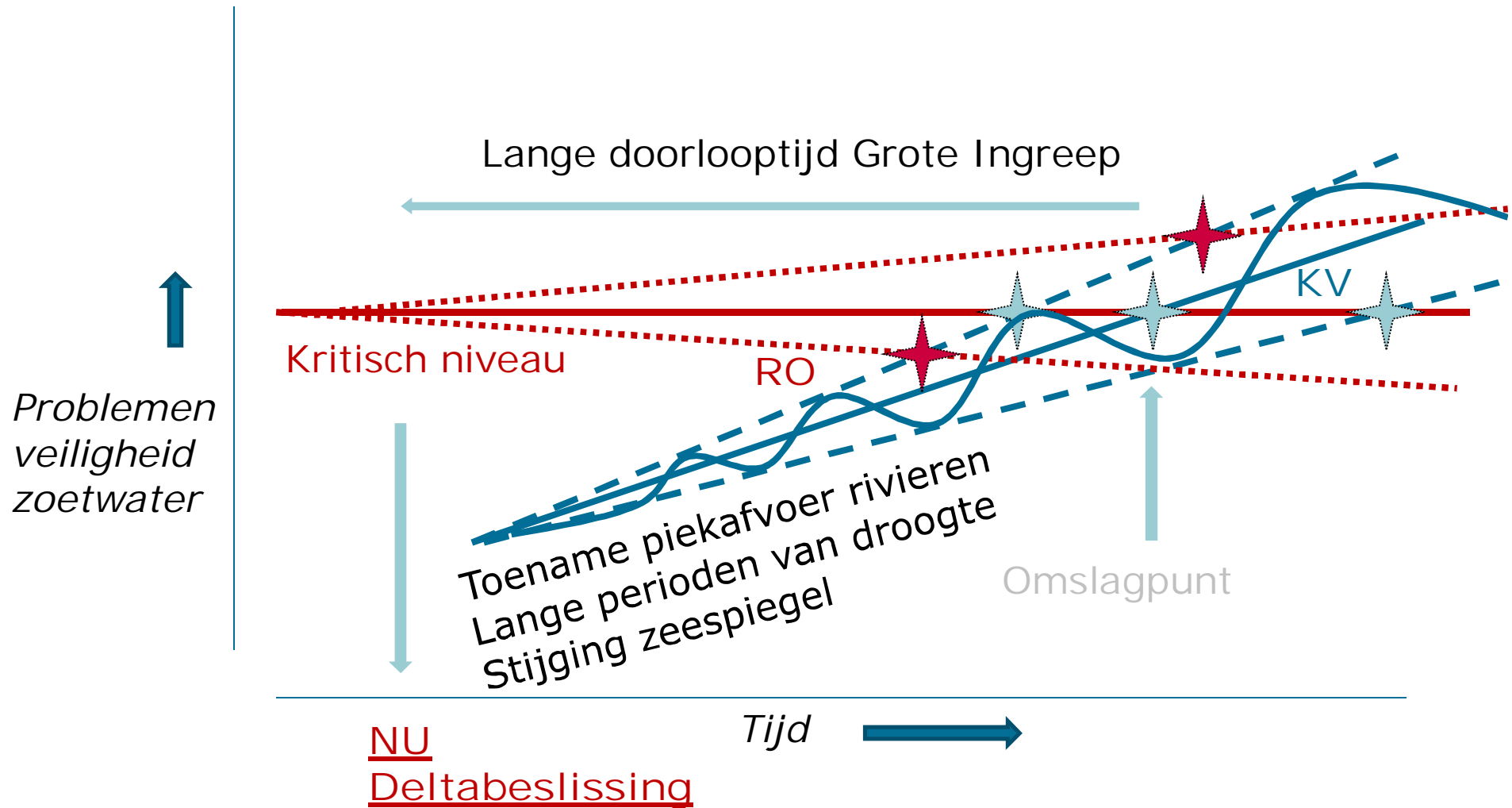



→ *Verken mogelijkheden "inbedding" in Deltaprogramma van...*

1. ...projecten waarin geanticipeerd wordt op de grote wateropgaven (gebiedsontwikkeling, projecten met natuur / landschap / recreatie doelstelling, ...)



→ Aanleg klimaatbuffers

2. ...kostenefficiënte ex-ante inpassingen van grote 'lange termijn' ingrepen



→ Bypass bij Kampen

3. ...aanpassingen van reguliere projecten die ikv beheer, onderhoud en vervanging worden geïnitieerd



→ Vervanging sluizen in de Maas

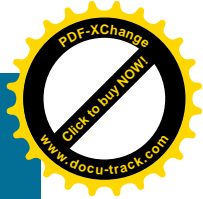
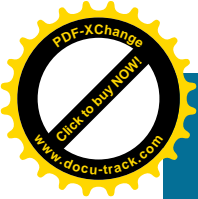

B. Flexibiliteit in het 'wanneer'



Toelichting op actie 1: financiering

Voorstel: verkenning mogelijkheden lenen uit de toekomst voor kosten-effectieve maatregelen uit Deltafonds

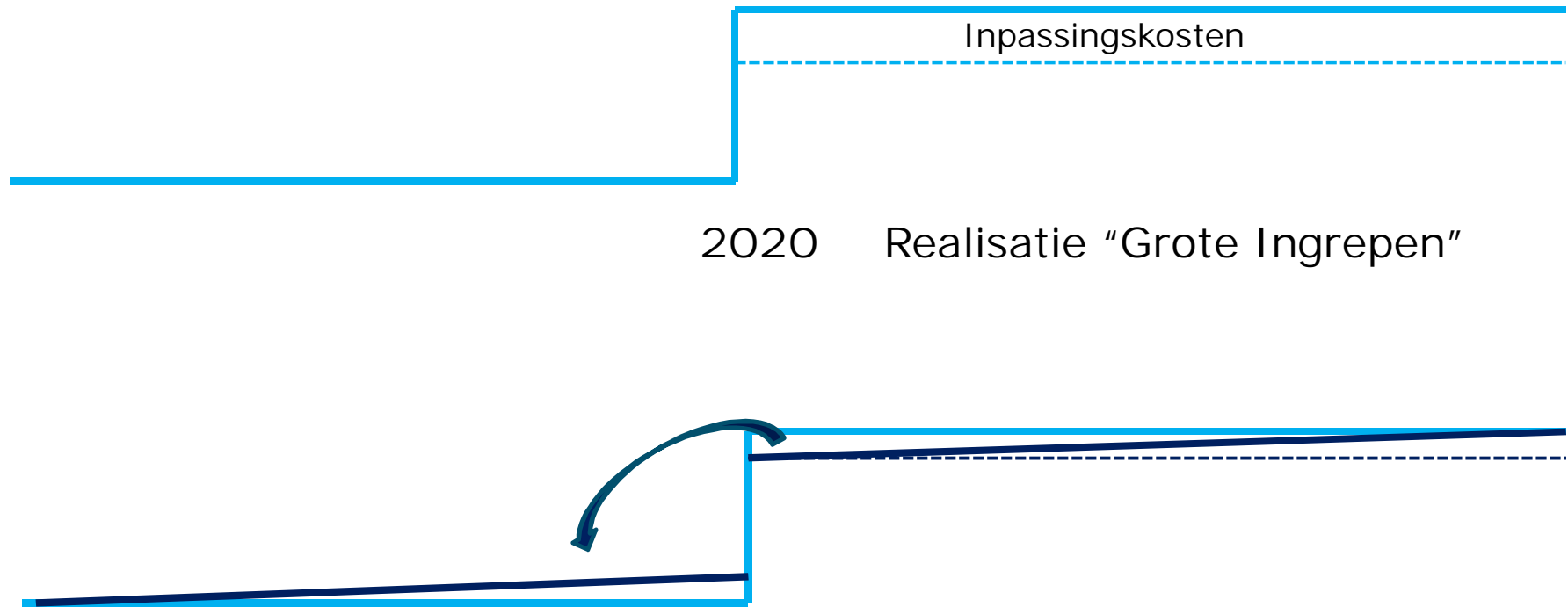

2020 Realisatie "Grote Ingrepen"

Realisatie k.e. "korte termijn maatr." 2020 Realisatie "Grote Ingrepen"

Andere voorbeelden: regionale waterbeheerders, Infracfonds, Nota Ruimte, provincies, institutionele beleggers

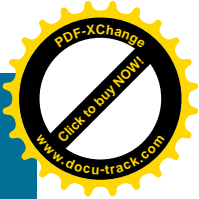
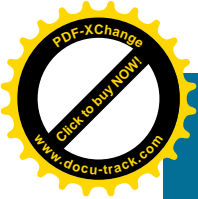

1. Bekendheid met benadering

Presentaties, discussiebijeenkomsten, workshops bij departementen, beleids/programmadiirecteuren DP, RWS, waterschappen, provincies

2. Uitwerking methodiek

Verkenning met departementen en kennisinstututen van juridische, bestuurlijk en financiële aspecten en aanscherping methodiek; incl. verkenning mogelijkheden lenen uit de toekomst

3. Ondersteuning deelprogramma's

Expertise beschikbaar stellen tbv ontwikkelen strategieën; parallel ontwikkelen handreiking

4. Pilots

kwantitatief doorrekenen van concrete situaties met goede kansen en politiek draagvlak; bv Ooijen-Wanssum, Afsluitdijk, Volkerak-Zoommeer.